



OMNI-DIRECTIONAL SOLUTIONS SINCE 1909

**9444 OMNITRACK  
HIGH CAPACITY  
BALL TRANSFER UNIT**  
REVISION # 01

REMOVABLE & REUSABLE 'SPIROLOX' CIRCLIP  
ALLOWS CLEANING/USER SERVICING

Available Material Options			
Part #	Load Bearing Internal Materials	Ball Material	Casing Material & Finish
9444	AISI 52100	AISI 52100	AISI 1012 ZINC/ELECTROPHORETIC (BLACK)
9444A	AISI 52100	AISI 440	AISI 1012 ZINC/ELECTROPHORETIC (BLACK)
9444Z	AISI 440	AISI 440	AISI 1012 ELECTROPHORETIC (BLACK)
9444SS	AISI 440	AISI 440	AISI 304 - NATURAL

SPRING MATERIAL FOR ALL OPTIONS = LIGHTLY GREASED CARBON STEEL

~ Operating temperature -20° C + 125° C (continuous)

**NOTES:**

1. SUPPORTS A LOAD OF 680 Kg / 1500 Lbs
2. MAXIMUM RECOMMENDED DEFLECTION 9,2mm [0.360"]
3. 960 Kg / 2113 Lbs LOAD AT MAXIMUM DEFLECTION

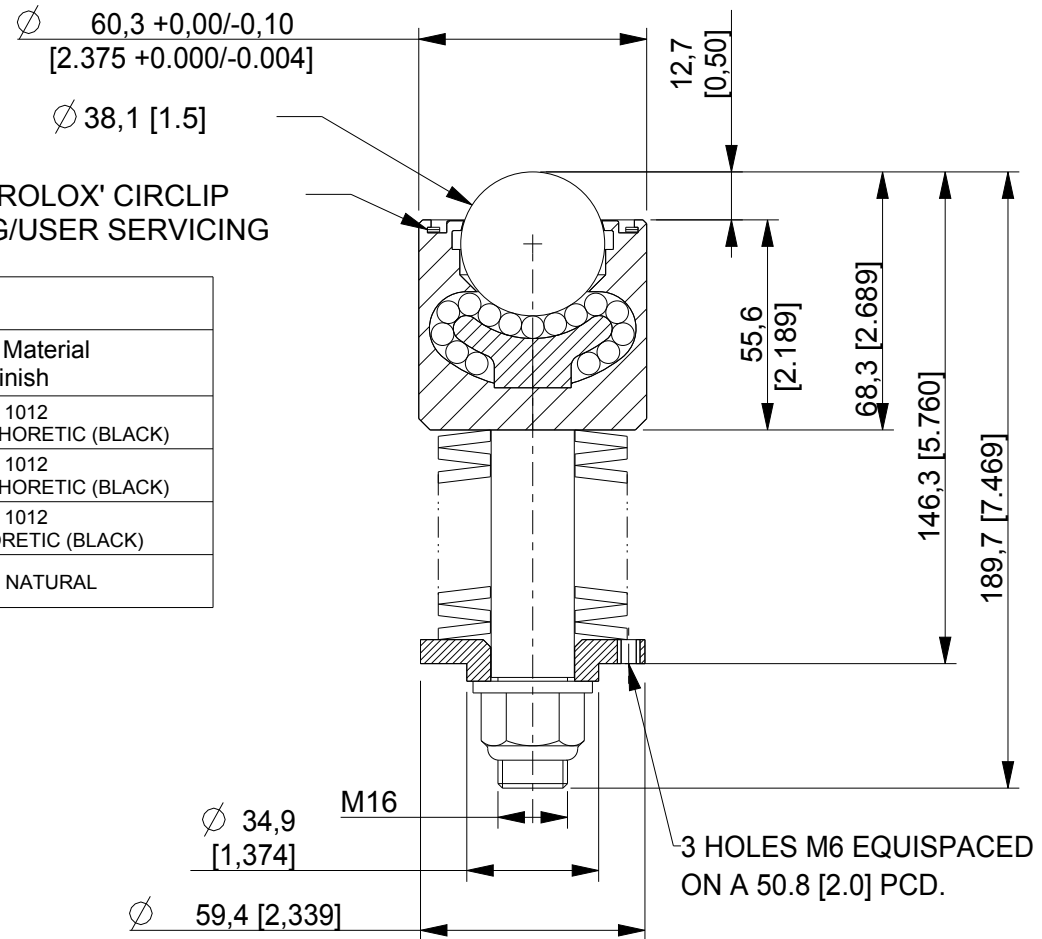

ALL DIMENSIONS IN mm [inch]  
IF VIEWED AS PDF, DO NOT SCALE  
IF VIEWED AS DWG, SCALE 1 : 2  
TOLERANCE  $\pm 0,25$   
QMF 31 ISSUE 01 : 22/06/2012

**OMNITRACK**  
RODBOROUGH COURT  
STROUD, GL5 3LR, ENGLAND

Telephone: +44 (0)1453 873 345  
Fax: +44 (0)1453 878 500  
info @ omnitrack.com  
www.omnitrack.com

THIS DOCUMENT CONTAINS OMNITRACK  
PROPERTY AND CONFIDENTIAL INFORMATION.  
IT IS LOANED FOR LIMITED PURPOSES ONLY  
AND REMAINS THE PROPERTY OF OMNITRACK.  
IT MAY NOT BE REPRODUCED IN WHOLE  
OR PART OR DISCLOSED TO THIRD PARTIES  
WITHOUT THE PRIOR WRITTEN CONSENT OF  
OMNITRACK. THE DOCUMENT IS TO BE  
RETURNED TO OMNITRACK UPON REQUEST  
AND IN ALL EVENTS UPON COMPLETION OF THE  
USE FOR WHICH IT WAS LOANED