



OMNI-DIRECTIONAL SOLUTIONS SINCE 1909

**9445 OMNITRACK
HIGH CAPACITY
BALL TRANSFER UNIT**
REVISION # 01

REMOVABLE & REUSABLE 'SPIROLOX' CIRCLIP
ALLOWS CLEANING/USER SERVICING

Available Material Options			
Part #	Load Bearing Internal Materials	Ball Material	Casing Material & Finish
9445	AISI 52100	AISI 52100	AISI 1012 ZINC/ELECTROPHORETIC (BLACK)
9445A	AISI 52100	AISI 440	AISI 1012 ZINC/ELECTROPHORETIC (BLACK)
9445Z	AISI 440	AISI 440	AISI 1012 ELECTROPHORETIC (BLACK)
9445SS	AISI 440	AISI 440	AISI 304 - NATURAL

SPRING MATERIAL FOR ALL OPTIONS = LIGHTLY GREASED CARBON STEEL

~ Operating temperature -20° C + 125° C (continuous)

NOTES:

1. SUPPORTS A LOAD OF 748 Kg / 1650 Lbs
2. MAXIMUM RECOMMENDED DEFLECTION 8,2mm [0.323"]
3. 960 Kg / 2113 Lbs LOAD AT MAXIMUM DEFLECTION

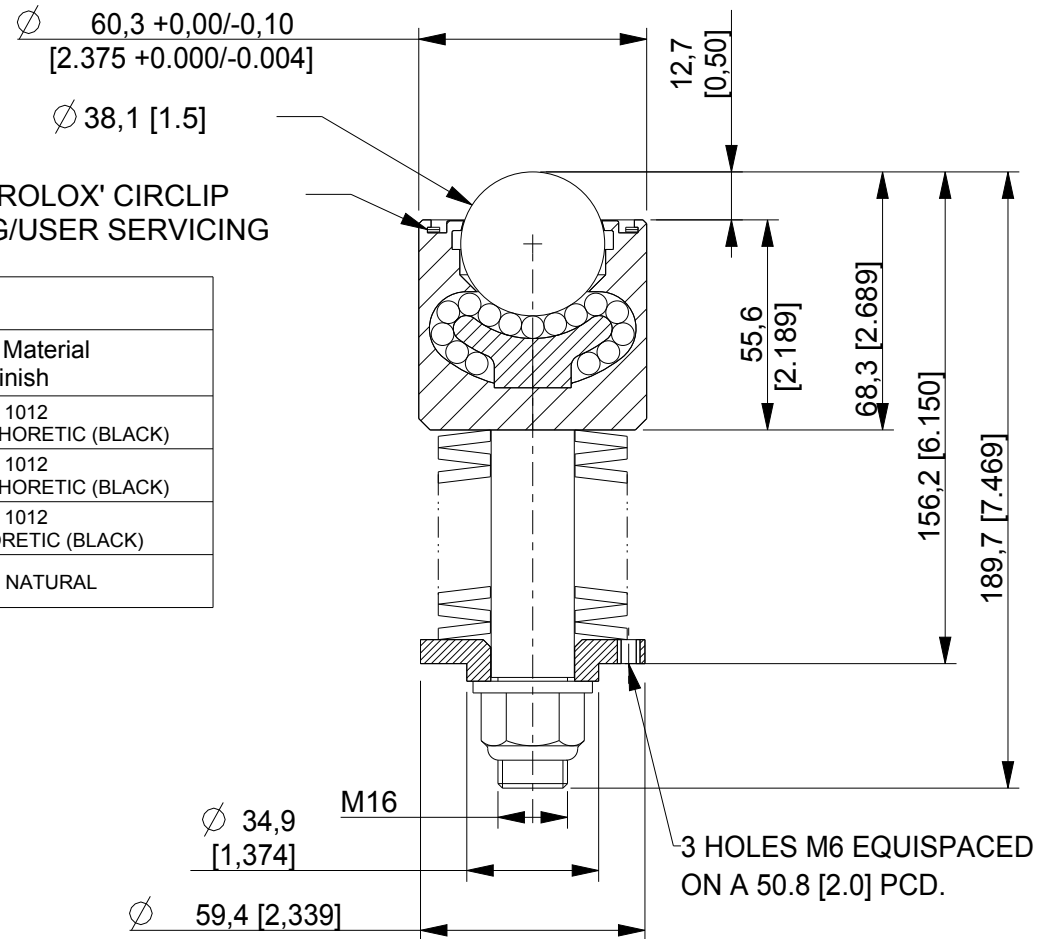

ALL DIMENSIONS IN mm [inch]
IF VIEWED AS PDF, DO NOT SCALE
IF VIEWED AS DWG, SCALE 1 : 2
TOLERANCE $\pm 0,25$
QMF 31 ISSUE 01 : 22/06/2012

OMNITRACK
RODBOROUGH COURT
STROUD, GL5 3LR, ENGLAND

Telephone: +44 (0)1453 873 345
Fax: +44 (0)1453 878 500
info @ omnitrack.com
www.omnitrack.com

THIS DOCUMENT CONTAINS OMNITRACK
PROPERTY AND CONFIDENTIAL INFORMATION.
IT IS LOANED FOR LIMITED PURPOSES ONLY
AND REMAINS THE PROPERTY OF OMNITRACK.
IT MAY NOT BE REPRODUCED IN WHOLE
OR PART OR DISCLOSED TO THIRD PARTIES
WITHOUT THE PRIOR WRITTEN CONSENT OF
OMNITRACK. THE DOCUMENT IS TO BE
RETURNED TO OMNITRACK UPON REQUEST
AND IN ALL EVENTS UPON COMPLETION OF THE
USE FOR WHICH IT WAS LOANED