

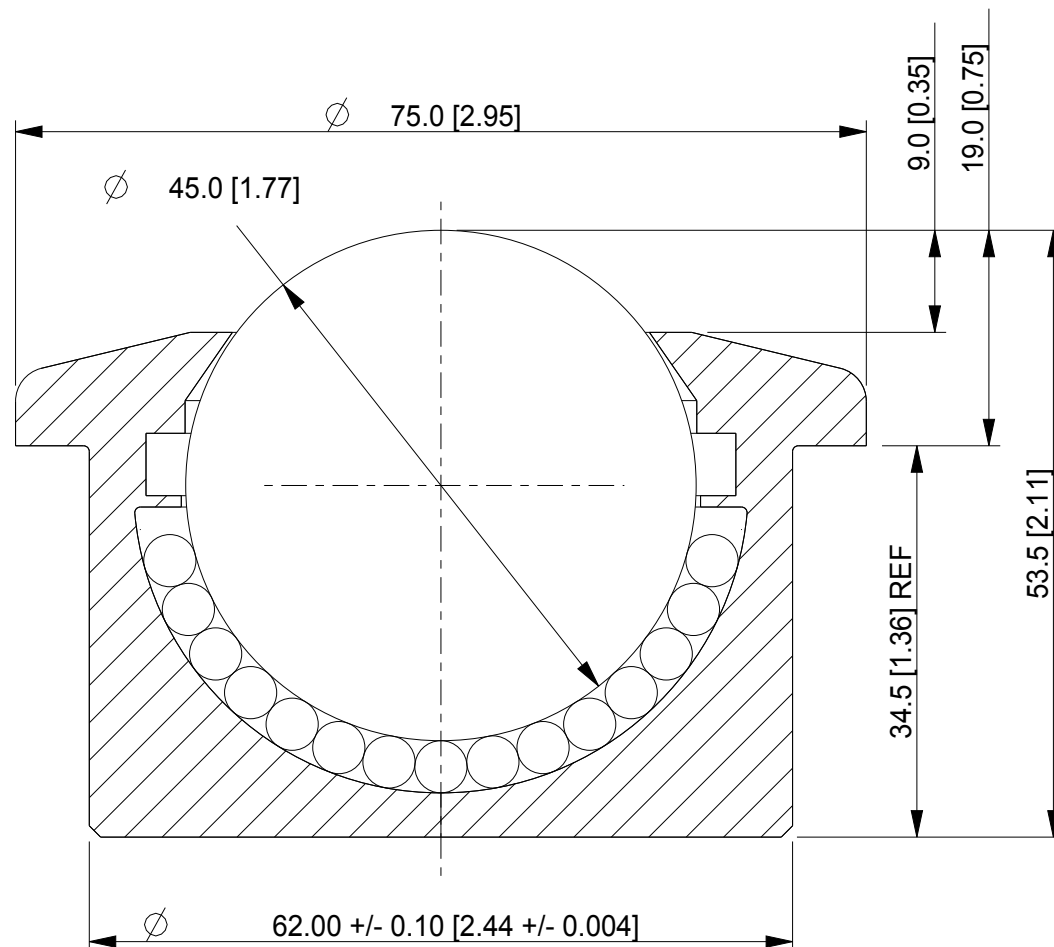

OMNI-DIRECTIONAL SOLUTIONS

LP45 OMNITRACK
LIGHT DUTY
BALL TRANSFER UNIT

REVISION # 01



Available Material Options

Part #	Load Capacity	Main Ball Material	Casing material & finish	Weight
LP 45	20 kg	Acetal (POM)	Acetal (POM)	0.176 kg
LP 45-A	20 kg	AISI 316	Acetal (POM)	0.502 kg

ALL DIMENSIONS IN mm [inch]
IF VIEWED AS PDF, DO NOT SCALE
IF VIEWED AS DWG, SCALE 3 : 2
TOLERANCE \pm 0,25
QMF 31 ISSUE 01 : 22/06/2012

OMNITRACK LTD
RODBOROUGH COURT
STROUD, GL5 3LR, ENGLAND

Telephone: +44 (0)1453 873 345
Fax: +44 (0)1453 878 500
info @ omnitrack.com
www.omnitrack.com

THIS DOCUMENT CONTAINS OMNITRACK LTD PROPERTY AND CONFIDENTIAL INFORMATION. IT IS LOANED FOR LIMITED PURPOSES ONLY AND REMAINS THE PROPERTY OF OMNITRACK LTD. IT MAY NOT BE REPRODUCED IN WHOLE OR PART OR DISCLOSED TO THIRD PARTIES WITHOUT THE PRIOR WRITTEN CONSENT OF OMNITRACK LTD. THE DOCUMENT IS TO BE RETURNED TO OMNITRACK LTD UPON REQUEST AND IN ALL EVENTS UPON COMPLETION OF THE USE FOR WHICH IT WAS LOANED