



OMNI-DIRECTIONAL SOLUTIONS

MS22 OMNITRACK MEDIUM DUTY BALL TRANSFER UNIT

REVISION # 01

Available Material Options				
Part #	Load bearing internal materials	Main Ball Material	Casing material & finish	Load Capacity
MS 22	AISI 52100	AISI 52100	AISI 1015 -Zinc plated	180 kg
MS 22-A	AISI 52100	AISI 420	AISI 1015 -Zinc plated	126 kg
MS 22-SS	AISI 420	AISI 420	AISI 420 - Natural	126 kg
MS 22-D	AISI 52100	Acetal (POM)	AISI 1015 -Zinc plated	18 kg

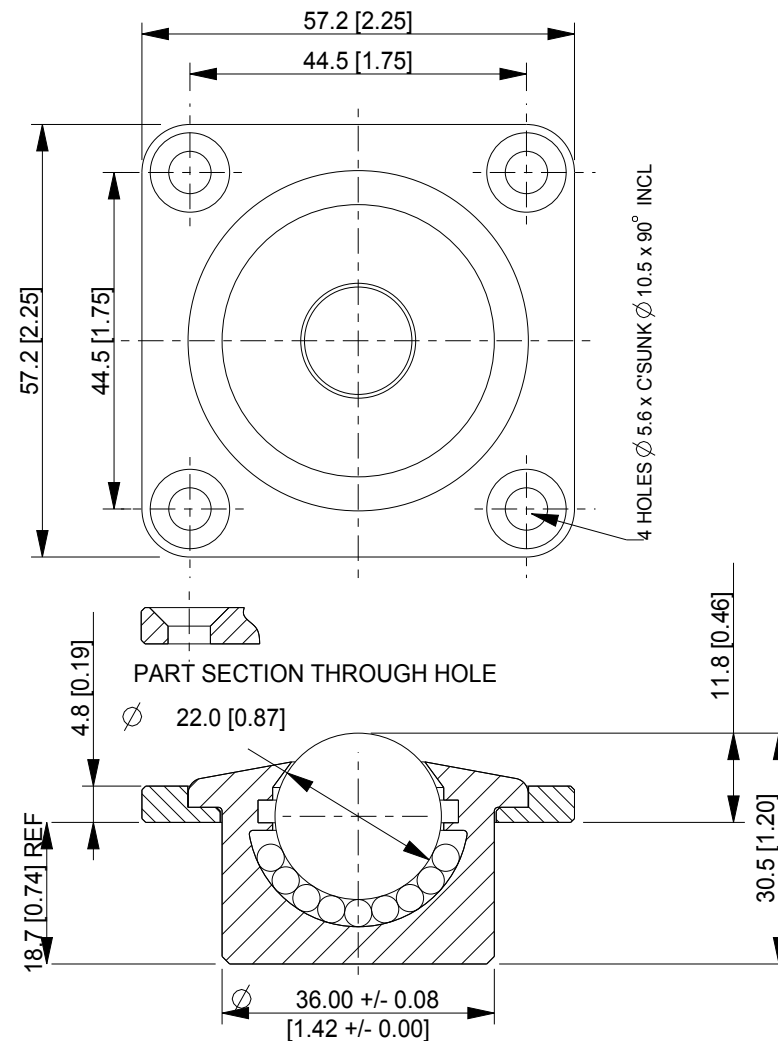

ALL DIMENSIONS IN mm [inch]
IF VIEWED AS PDF, DO NOT SCALE
IF VIEWED AS DWG, SCALE 1 : 1
TOLERANCE ± 0.25
QMF 31 ISSUE 01 : 22/06/2012

OMNITRACK LTD
RODBOROUGH COURT
STROUD, GL5 3LR, ENGLAND

Telephone: +44 (0)1453 873 345
Fax: +44 (0)1453 878 500
info @ omnitrack.com
www.omnitrack.com

THIS DOCUMENT CONTAINS OMNITRACK LTD PROPERTY AND CONFIDENTIAL INFORMATION. IT IS LOANED FOR LIMITED PURPOSES ONLY AND REMAINS THE PROPERTY OF OMNITRACK LTD. IT MAY NOT BE REPRODUCED IN WHOLE OR PART OR DISCLOSED TO THIRD PARTIES WITHOUT THE PRIOR WRITTEN CONSENT OF OMNITRACK LTD. THE DOCUMENT IS TO BE RETURNED TO OMNITRACK LTD UPON REQUEST AND IN ALL EVENTS UPON COMPLETION OF THE USE FOR WHICH IT WAS LOANED