

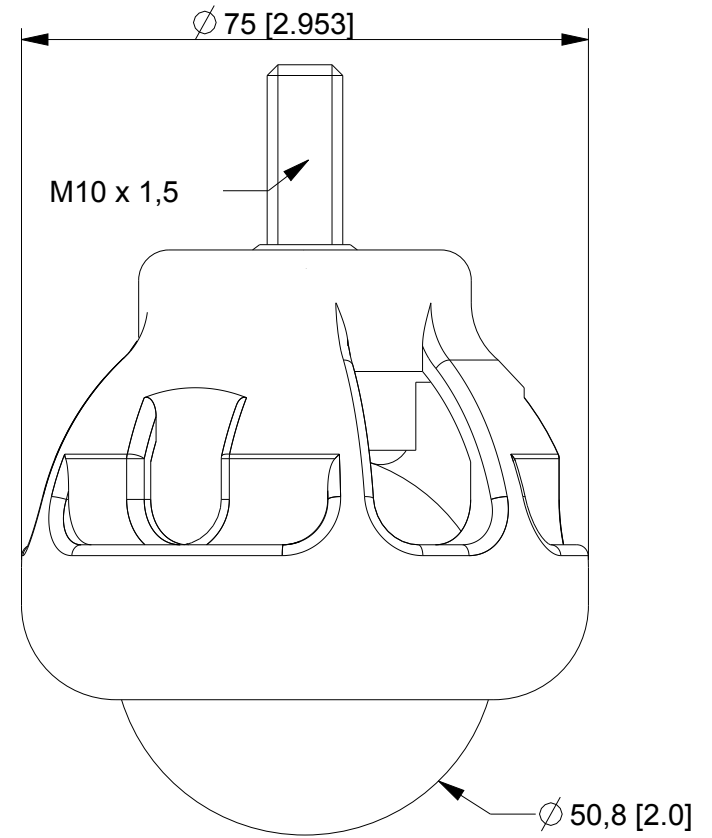

OMNI-DIRECTIONAL SOLUTIONS SINCE 1909

OC50 OMNICASTER
 "TIGHT TURN"
 BALL CASTER UNIT
 REVISION # 01

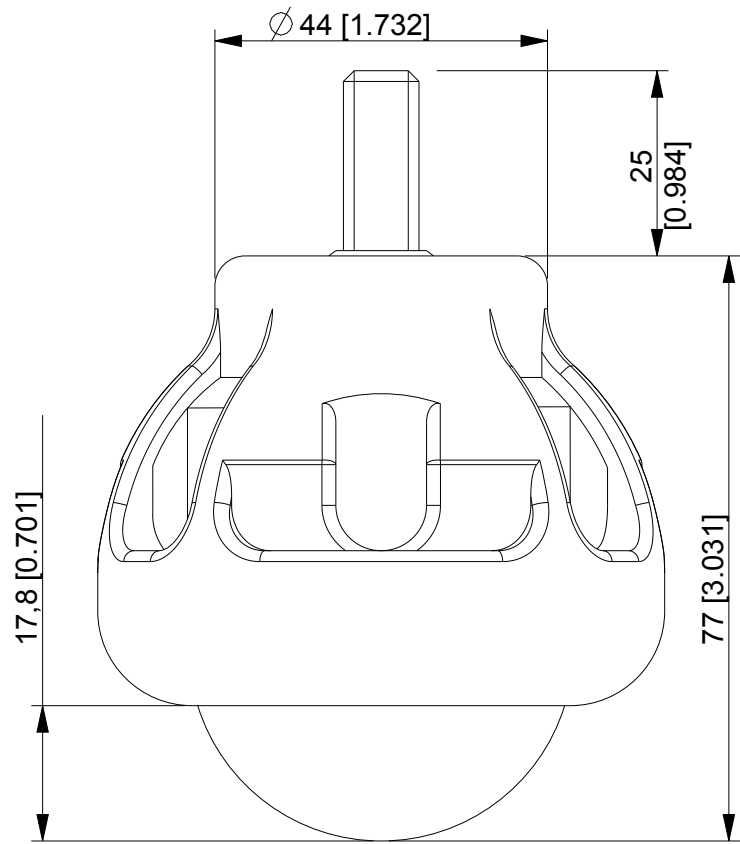

PART NUMBER	LOAD BEARING COMPONENT	HOUSING
OC50	PHENOLIC RESIN	POLYPROPYLENE

LOAD CAPACITY 60 Kg / 132 Lbs

ALL DIMENSIONS IN mm [inch]
 IF VIEWED AS PDF, DO NOT SCALE
 IF VIEWED AS DWG, SCALE 1 : 1
 TOLERANCE ± 0,25
 QMF 31 ISSUE 01 : 22/06/2012

OMNITRACK
 RODBOROUGH COURT
 STROUD, GL5 3LR, ENGLAND

Telephone: +44 (0)1453 873 345
 Fax: +44 (0)1453 878 500
 info @ omnitrack.com
 www.omnitrack.com

THIS DOCUMENT CONTAINS OMNITRACK PROPERTY AND CONFIDENTIAL INFORMATION. IT IS LOANED FOR LIMITED PURPOSES ONLY AND REMAINS THE PROPERTY OF OMNITRACK. IT MAY NOT BE REPRODUCED IN WHOLE OR PART OR DISCLOSED TO THIRD PARTIES WITHOUT THE PRIOR WRITTEN CONSENT OF OMNITRACK. THE DOCUMENT IS TO BE RETURNED TO OMNITRACK UPON REQUEST AND IN ALL EVENTS UPON COMPLETION OF THE USE FOR WHICH IT WAS LOANED